



Pumpen Intelligenz.

Residential Wet Rotor Circulators

WILO Star

Product Brochure.



Star Model Dimensions

Stainless Steel Shaft
Quick Connect Wiring
Steel Terminal Box
Fits all Competitor's Models
Powerful Starting Torque



Ultra Quiet
Reliable Wet Rotor Technology
Optional Check Valve
Automatically Vented
Single or 3 Speed Models

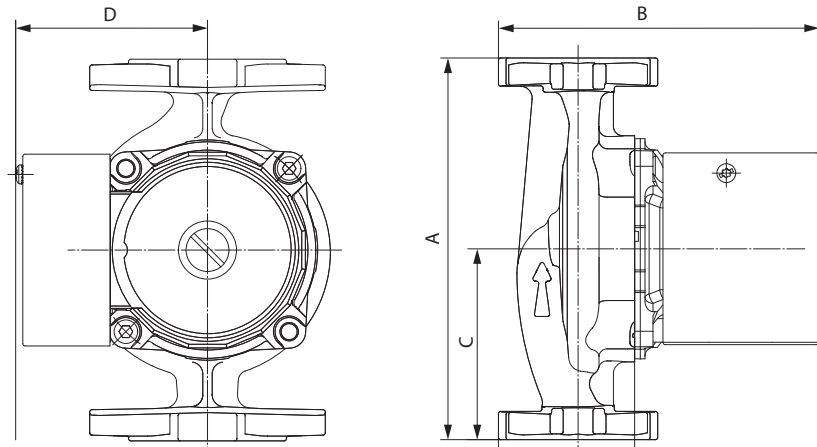

SINGLE SPEED

TYPE	A	B	C	D	AMPS	WT
Star 5 FX	6-3/8" (162mm)	5-15/16" (150mm)	3-3/16" (81mm)	3-3/16" (81mm)	0.46	6.5 lbs (3.0 kg)
Star 16 F	6-3/8" (162mm)	5-15/16" (150mm)	3-3/16" (81mm)	3-3/16" (81mm)	0.70	6.5 lbs (3.0 kg)
Star 16 FX	6-3/8" (162mm)	5-15/16" (150mm)	3-3/16" (81mm)	3-3/16" (81mm)	0.70	6.5 lbs (3.0 kg)
Star 21 F	6-3/8" (162mm)	5-15/16" (150mm)	3-3/16" (81mm)	3-3/16" (81mm)	0.95	6.5 lbs (3.0 kg)
Star 21 FX	6-3/8" (162mm)	5-15/16" (150mm)	3-3/16" (81mm)	3-3/16" (81mm)	0.95	6.5 lbs (3.0 kg)
Star 32 F	6-3/8" (162mm)	5-3/8" (136mm)	3-3/16" (81mm)	3-3/16" (81mm)	0.99	6.7 lbs (3.1 kg)
Star 30 F	6-1/2" (165mm)	6" (153mm)	3-1/4" (82mm)	3-1/4" (82mm)	1.50	8 lbs (3.7 kg)
Star 17 FX	8-1/2" (216mm)	7" (176mm)	4-1/4" (102mm)	3-2/9" (76mm)	1.70	10 lbs (4.6 kg)
Star 32 BF	6-3/8" (162mm)	5-3/8" (136mm)	3-3/16" (81mm)	3-3/16" (81mm)	0.99	6.7 lbs (3.1 kg)
Star 5 BFX	6-3/8" (162mm)	5-15/16" (150mm)	3-3/16" (81mm)	3-3/16" (81mm)	0.46	6.5 lbs (3.0 kg)
Star 16 BFX	6-3/8" (162mm)	5-15/16" (150mm)	3-3/16" (81mm)	3-3/16" (81mm)	0.70	7.2 lbs (3.2 kg)
Star 21 BFX	6-3/8" (162mm)	5-15/16" (150mm)	3-3/16" (81mm)	3-3/16" (81mm)	0.95	7.1 lbs (3.2 kg)
Star 3 BS 5	5" (127mm)	4-15/16" (125mm)	2-1/2" (64mm)	3-3/16" (81mm)	0.46	6.5 lbs (3.0 kg)
Star 3 BS 7	5" (127mm)	4-15/16" (125mm)	2-1/2" (64mm)	3-3/16" (81mm)	0.46	5.3 lbs (2.4 kg)
Star 8 BS 5	5" (127mm)	4-15/16" (125mm)	2-1/2" (64mm)	3-3/16" (81mm)	0.57	6.5 lbs (3.0 kg)
Star 8 BS 7	5" (127mm)	4-15/16" (125mm)	2-1/2" (64mm)	3-3/16" (81mm)	0.57	5.3 lbs (2.4 kg)
Star 5 BU	6" (130mm)	5-1/8" (130mm)	3" (76mm)	3-3/16" (81mm)	0.46	6.5 lbs (3.0 kg)
Star 11 BU	6" (130mm)	5-1/8" (130mm)	3" (76mm)	3-3/16" (81mm)	0.57	6.5 lbs (3.0 kg)

3 SPEED

TYPE	A	B	C	D	AMPS	WT
Star S 16 F	6-3/8" (162mm)	6-3/8" (162mm)	3-3/16" (81mm)	3-3/16" (81mm)	0.66 max	6.5 lbs (3.0 kg)
Star S 16 FX	6-3/8" (162mm)	6-3/8" (162mm)	3-3/16" (81mm)	3-3/16" (81mm)	0.66 max	6.5 lbs (3.0 kg)
Star S 16 BFX	6-3/8" (162mm)	6-3/8" (162mm)	3-3/16" (81mm)	3-3/16" (81mm)	0.66 max	7.0 lbs (3.2 kg)
Star S 21 F	6-3/8" (162mm)	6-3/8" (154mm)	3-3/16" (81mm)	3-3/16" (81mm)	0.92 max	6.5 lbs (3.0 kg)
Star S 21 FX	6-3/8" (162mm)	6-3/8" (154mm)	3-3/16" (81mm)	3-3/16" (81mm)	0.92 max	6.5 lbs (3.0 kg)
Star S 21 BFX	6-3/8" (162mm)	6-3/8" (162mm)	3-3/16" (81mm)	3-3/16" (81mm)	0.92 max	7.1 lbs (3.2 kg)

Performance Curves

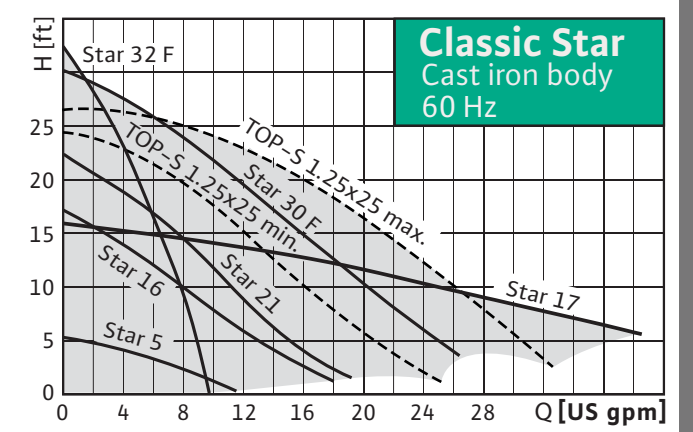
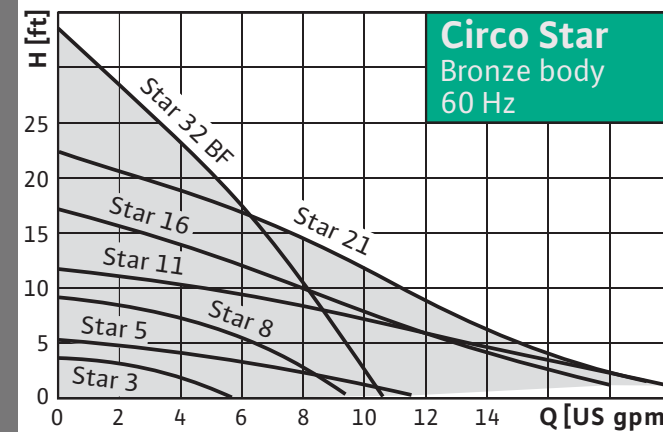
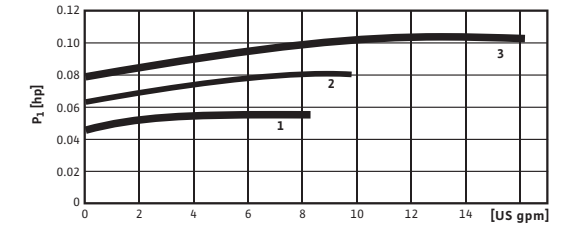
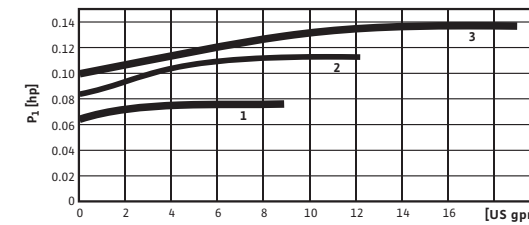
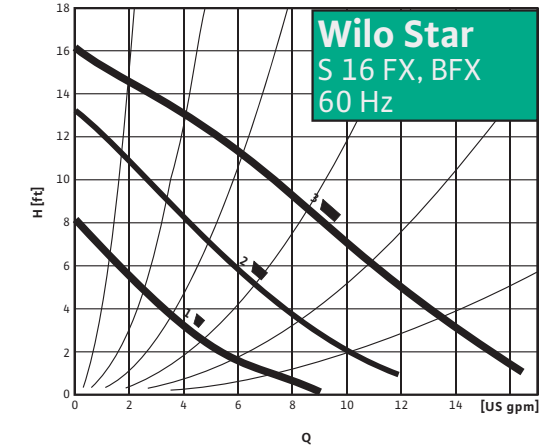
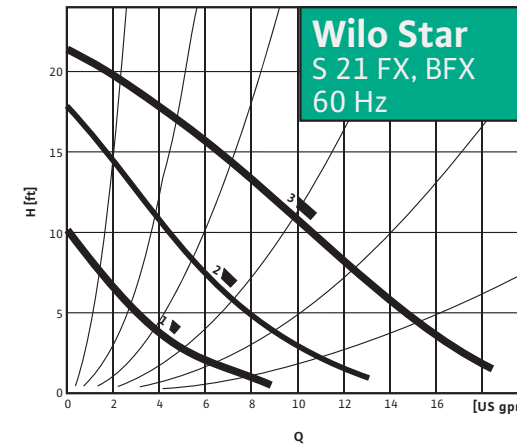

Classic Star
3 Speed



Circo Star



Classic Star

Model Number Designation

Type Key

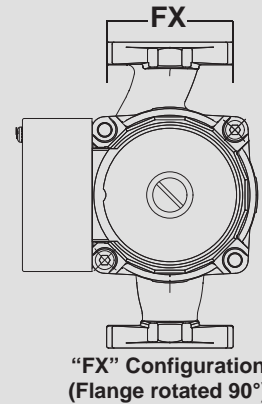
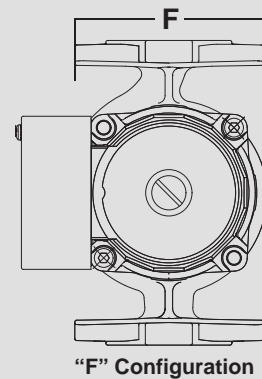
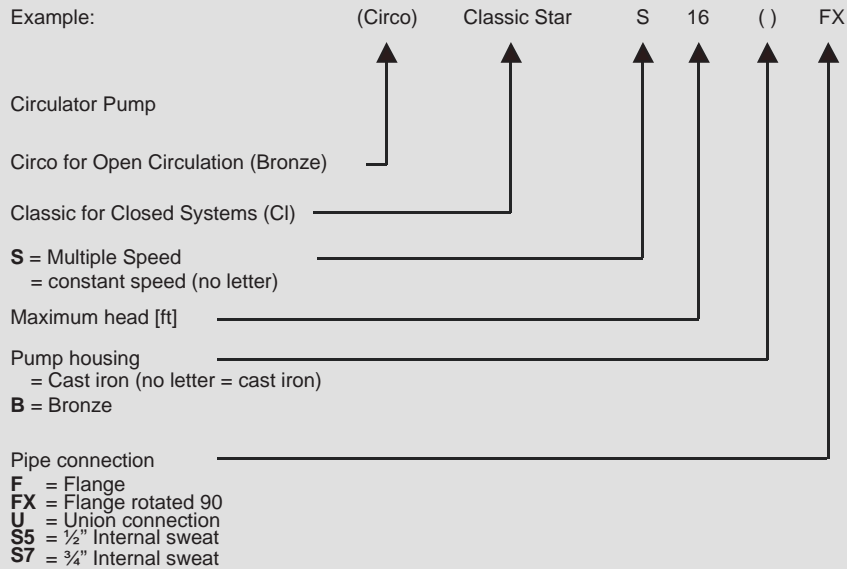

WILO Check Flange

- ✓ Fits all WILO residential flanged circulators
- ✓ Easy to clean
- ✓ Easy to remove air locks
- ✓ Cost effective
- ✓ Farther away from turbulent water



WILO Check Flange

WILO USA LLC
1290 N 25th Ave.
Melrose Park, IL
60160
1-866-WILO-USA
www.WILO-USA.com

WILO Canada Inc.
Bay #7 - 2915 10th Ave. NE
Calgary, Alberta
T2A 5L4
1-866-WILO-CDN
www.WILO-CANADA.com



Pumpen Intelligenz.